

MSE 30/5 - MSE 6025  
0,7 VA ... 44 VA

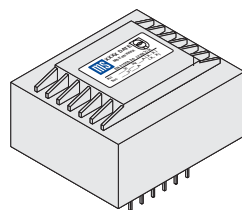

04.01 - 04.07

## power table pcb transformers potted MSE

- \* safety transformer satisfying EN 60742 ( VDE 0551) / EN 61558-2-6 (  $U_o < 50 V$  )
- \* construction in vacuum potted double chamber style
- \* complete construction with UL-approved material
- \*  $U_o > 50 V$ : insulation-transformer according EN 61558-2-4
- \* one or two windings primary, until four windings secondary
- \* extremely small magnetic perturbation field due to optimized core geometry and very good power efficiency
- \* advantageous price / quality ratio
- \* automated production yields highest reliability
- \* special version on demand
- \* optional: temperature fuse / PTC / fail-safe
- \* EI 30: until 3,0 VA short circuit proof; from 3,2 VA with temperature-fuse under condition short circuit proof

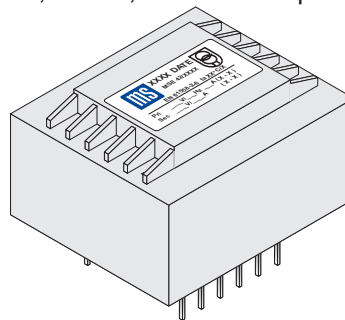

type	pins	dimensions [ mm ]			power [ VA ]			
		length L	width B	height h	ta 40°C/B		ta 70°C/B	
					compact	economy	compact	economy
MSE 30/5	2 x 5	35	30,5	15			0,9	0,7
MSE 30/10,5	2 x 5	35	30,5	23			2,1	1,8
MSE 30/12,5	2 x 5	35	30,5	25			3,0	2,2
MSE 30/15,5	2 x 5	35	30,5	28			3,6	3,2
MSE 30/18	2 x 5	35	30,5	31			4,2	3,8
MSE 30/23	2 x 5	35	30,5	36			5,2	4,7
MSE 38/13,6	2 x 5	45	38,5	28,5	9,0	7,5	6,8	5,5
MSE 42/14,8	2 x 6	49	42	32,5	10,5	9,0	8,0	6,8
MSE 42/20	2 x 6	49	42	38	14,5	12,0	11,0	9,0
MSE 48/16,8	2 x 6	55,5	47,5	34,6	19,0	15,0	14,5	12,0
MSE 48/20,5	2 x 6	55,5	47,5	38,3	22,0	19,0	16,5	14,5
MSE 54/18,8	2 x 7	62	53	39	26,0	20,0	20,0	15,0
MSE 54/23	2 x 7	62	53	43	31,0	25,0	25,0	19,0
MSE 60/25	2 x 7	71	60	49	44,0	37,0	32,0	27,0

# type MSE 30 potted

0,7 ... 5,2 VA

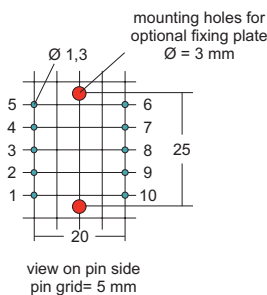
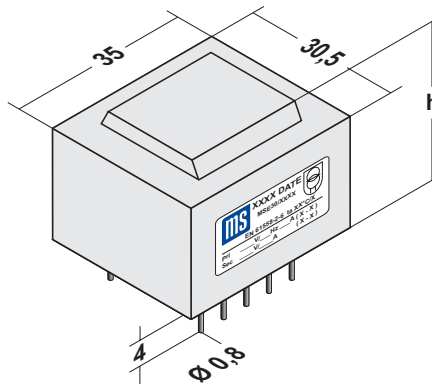

example for winding

MSE 30	type size [ mm ]	height [ mm ]	power [ VA ] ta 70°C/B			
			compact	short circuit proof	economy	short circuit proof
			MSE 30/5	15	0,9	yes
MSE 30/10,5	23	2,1	yes	1,8	yes	
MSE 30/12,5	25	3,0	yes	2,2	yes	
MSE 30/15,5	28	3,6	no	3,2	no	
MSE 30/18	31	4,2	no	3,8	no	
MSE 30/23	36	5,2	no	4,7	no	

- \* safety transformer satisfying EN 60742 ( VDE 0551 ) / EN 61558-2-6 ( U<sub>o</sub> < 50 V )
- \* construction in vacuum potted double chamber style
- \* approval according EN 61558, SEV, SEMKO, ENEC and CE-sign
- \* complete construction with UL-approved material
- \* automated production yields highest reliability
- \* extremely small magnetic perturbation field due to optimized core geometry and very good power efficiency
- \* advantageous price / quality ratio
- \* maximum one or two windings primary respectively secondary
- \* optional: temperature fuse / PTC / fail-safe
- \* optional: from MSE 30/10,5 with fixing plate for mounting with self tapping screw B2,9 x 9,5

9708

technical changes reserved

Balti Trafo OÜ

Vihtra tee 3a · 87701 VÄNDRA, ESTONIA

phone: +372 44 71 660 · fax: +372 44 71 667

info@msbaltitrafo.ee

www.msbaltitrafo.ee

04.02

# type MSE 38 potted

5,5 ... 9 VA

 (approvals in preparation)

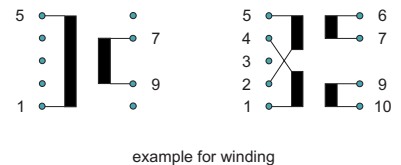
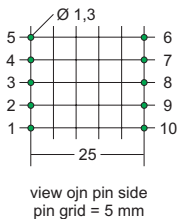
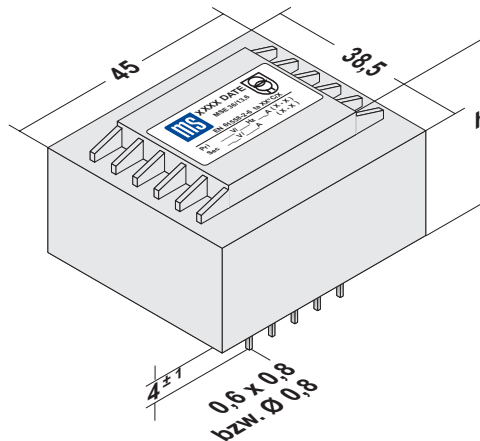

MSE 38	type size [ mm ]	height h [ mm ]	power [ VA ]			
			ta 40°C/B		ta 70°C/B	
			compact	economy	compact	economy
MSE 38/13,6	28,5	9,0	7,5	6,8	5,5	

- \* safety transformer satisfying EN 60742 ( VDE 0551 ) / EN 61558-2-6 ( U<sub>o</sub> < 50 V )
- \* construction in vacuum potted double chamber style
- \* approval according EN 61558, SEV, SEMKO, ENEC and CE-sign
- \* complete construction with UL-approved material
- \* automated production yields highest reliability
- \* extremely small magnetic perturbation field due to optimized core geometry and very good power efficiency
- \* advantageous price / quality ratio
- \* maximum one or two windings primary respectively secondary
- \* optional: temperature fuse / PTC / fail-safe

# type MSE 42 potted

6,8 ... 14,5 VA

 (approvals in preparation)

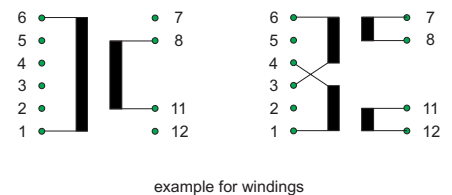
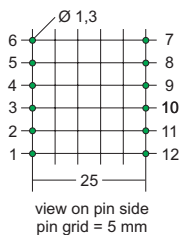
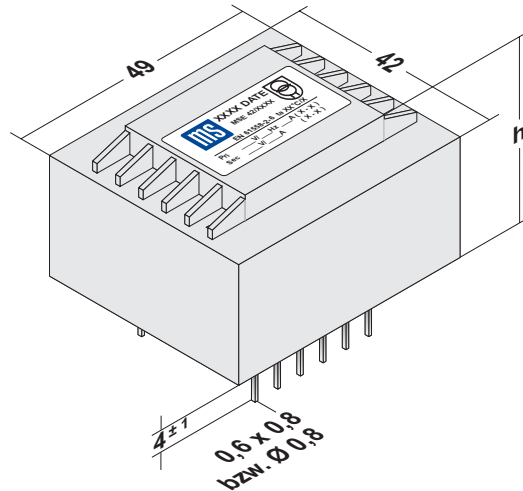

MSE 42	type size [ mm ]	height h [ mm ]	power [ VA ]			
			ta 40°C/B		ta 70°C/B	
			compact	economy	compact	economy
MSE 42/14,8	32,5	10,5	9,0	8,0	6,8	
MSE 42/20	38	14,5	12,0	11,0	9,0	

- \* safety transformer satisfying EN 60742 ( VDE 0551 ) / EN 61558-2-6 ( U<sub>o</sub> < 50 V )
- \* construction in vacuum potted double chamber style
- \* approval according EN 61558, SEV, SEMKO, ENEC and CE-sign
- \* complete construction with UL-approved material
- \* automated production yields highest reliability
- \* extremely small magnetic perturbation field due to optimized core geometry and very good power efficiency
- \* advantageous price / quality ratio
- \* maximum one or two windings primary respectively maximum 3 windings secondary
- \* optional: temperature fuse / PTC / fail-safe

# type MSE 48 potted

# 12 ... 22 VA

 (approvals in preparation)

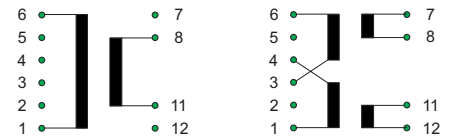
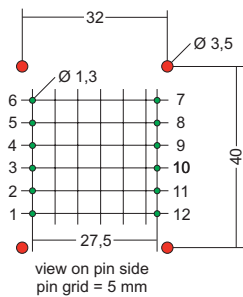
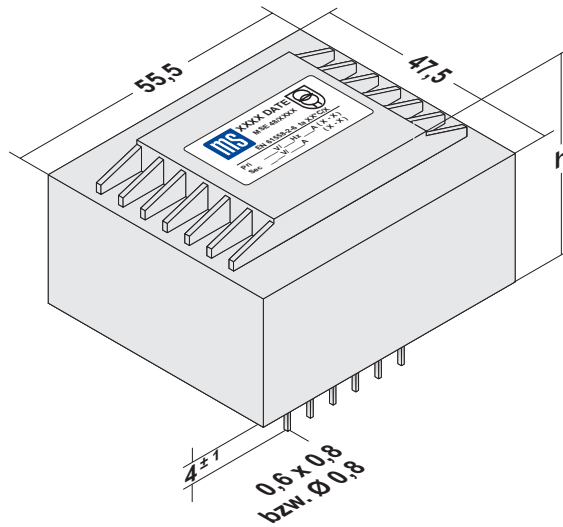

example for windings

MSE 48	type size [ mm ]	height h [ mm ]	power [ VA ]			
			ta 40°C/B		ta 70°C/B	
			compact	economy	compact	economy
MSE 48/16,8	34,6	19,0	15,0	14,5	12,0	
MSE 48/20,5	38,3	22,0	19,0	16,5	14,5	

- \* safety transformer satisfying EN 60742 ( VDE 0551 ) / EN 61558-2-6 ( U<sub>o</sub> < 50 V )
- \* construction in vacuum potted double chamber style
- \* approval according EN 61558, SEV, SEMKO, ENEC and CE-sign
- \* complete construction with UL-approved material
- \* automated production yields highest reliability
- \* extremely small magnetic perturbation field due to optimized core geometry and very good power efficiency
- \* advantageous price / quality ratio
- \* maximum one or two windings primary respectively maximum 3 windings secondary
- \* optional: temperature fuse / PTC / fail-safe
- \* optional: with 4 mounting holes for screw B2,9 x 9,5 DIN 7961

9901

technical changes reserved

# type MSE 54 potted

# 15 ... 31 VA

 (approvals in preparation)

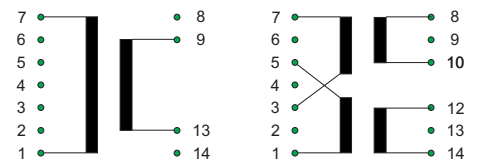
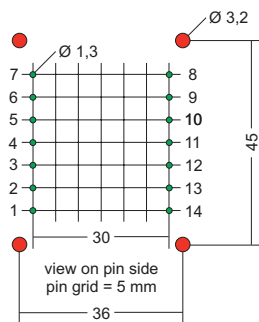
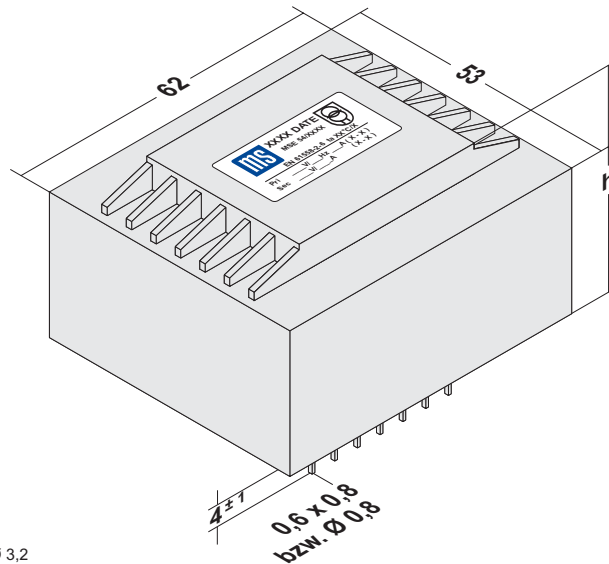

MSE 54	type size [ mm ]	height h [ mm ]	power [ VA ]			
			ta 40°C/B		ta 70°C/B	
			compact	economy	compact	economy
MSE 54/18,8	39	26	20	20	15	
MSE 54/23	43	31	25	25	19	

- \* safety transformer satisfying EN 60742 ( VDE 0551 ) / EN 61558-2-6 ( U<sub>0</sub> < 50 V )
- \* construction in vacuum potted double chamber style
- \* approval according EN 61558, SEV, SEMKO, ENEC and CE-sign
- \* complete construction with UL-approved material
- \* automated production yields highest reliability
- \* extremely small magnetic perturbation field due to optimized core geometry and very good power efficiency
- \* advantageous price / quality ratio
- \* maximum one or two windings primary respectively maximum 3 windings secondary
- \* optional: temperature fuse / PTC / fail-safe
- \* optional: with 4 mounting holes for screw B2,9 x 9,5 DIN 7961

9901

technical changes reserved

# type MSE 60 potted

27 ... 44 VA



(approvals in preparation)

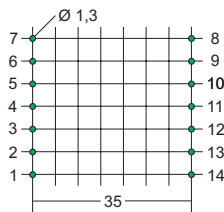
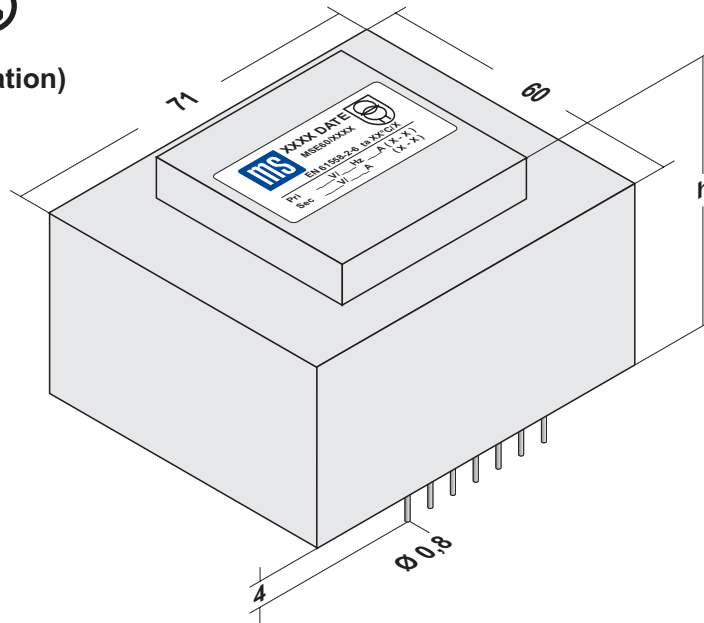

also pin grid 32,5

view on pin side  
pin grid = 5 mm

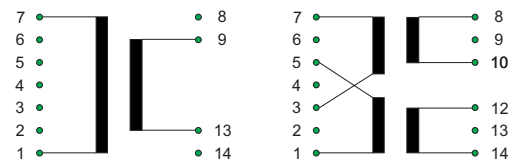

example for windings

MSE 60	type size [ mm ]	height h [ mm ]	power [ VA ]			
			ta 40°C/B		ta 70°C/B	
			compact	economy	compact	economy
	MSE 60/25	49	44	37	32	27

- \* safety transformer satisfying EN 60742 ( VDE 0551 ) / EN 61558-2-6 ( U<sub>o</sub> < 50 V )
- \* construction in vacuum potted double chamber style
- \* approval according EN 61558, SEV, SEMKO, ENEC and CE-sign
- \* complete construction with UL-approved material
- \* automated production yields highest reliability
- \* extremely small magnetic perturbation field due to optimized core geometry and very good power efficiency
- \* advantageous price / quality ratio
- \* maximum one or two windings primary respectively maximum 3 windings secondary
- \* optional: temperature fuse / PTC / fail-safe
- \* optional: housing with screw mounting (KK)